



6	-6		1	-1
7	-7		2	-2
8	-8		3	-3
9	-9		4	-4
10	-10		5	-5
	-12	.		-11



1 -1

2-1

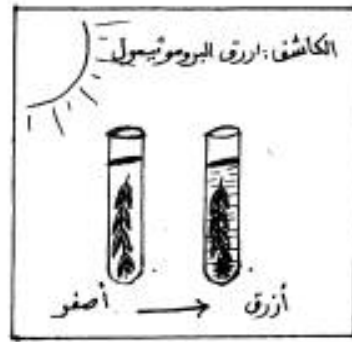
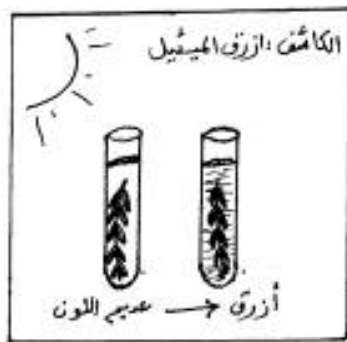

CO₂ : -
O₂ : -

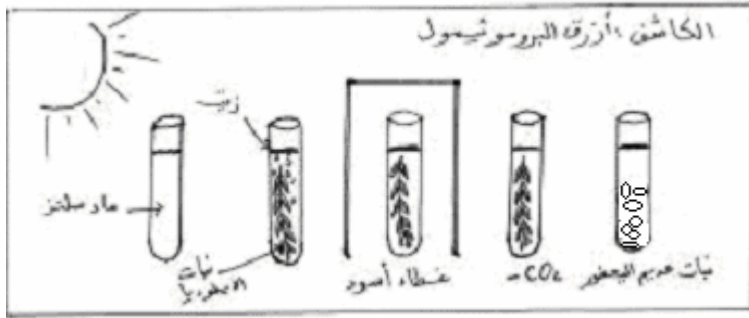

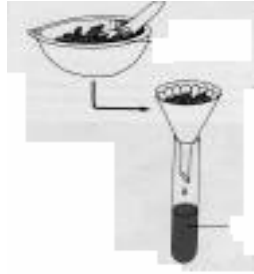

:

: (

:

:1

: :2

Wattman

2 (20x 120)

.(0.5- 1- 8.5)

1

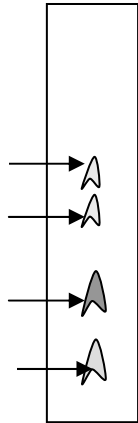

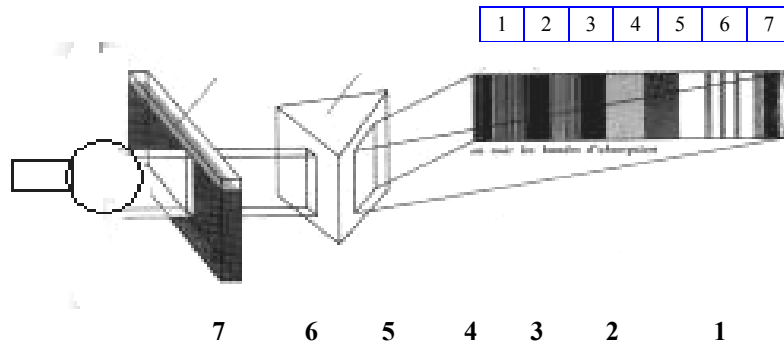

: 24
 () 10 •
 () •
 •
 •



6

-6

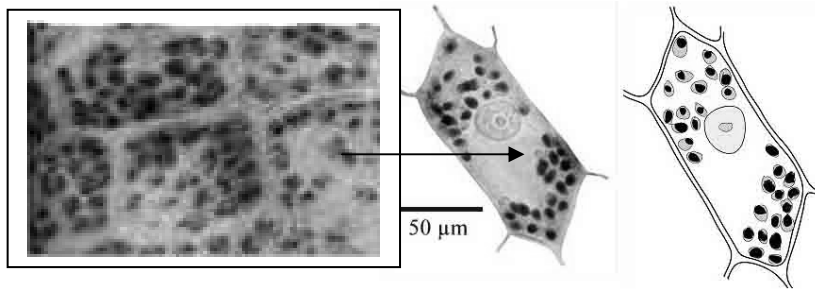

7 -7

:
O₂

(H₂O*)

8 -8

<i>I</i> O ₂	
6	200
30	800
45	1200
54	1600
71	2000
84	9000

:CO₂ -2

$/O_2$	%CO ₂
0	
7	0.01
15	0.03
29	0.05
43	0.07
62	0.09
74	0.1

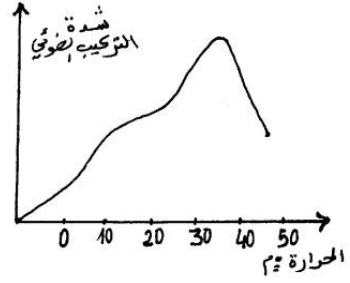

: -3

:

-

-

: -3

شدة التركيب الضوئي

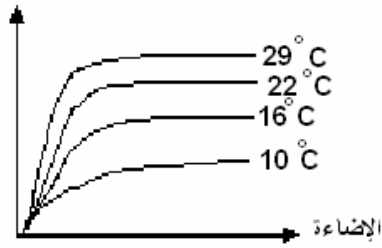

:

3

-
-
-
-

()

.5

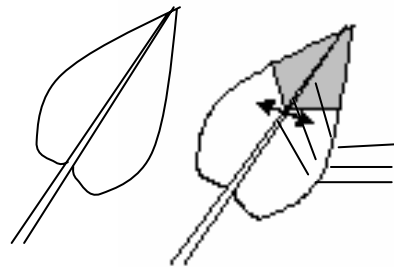

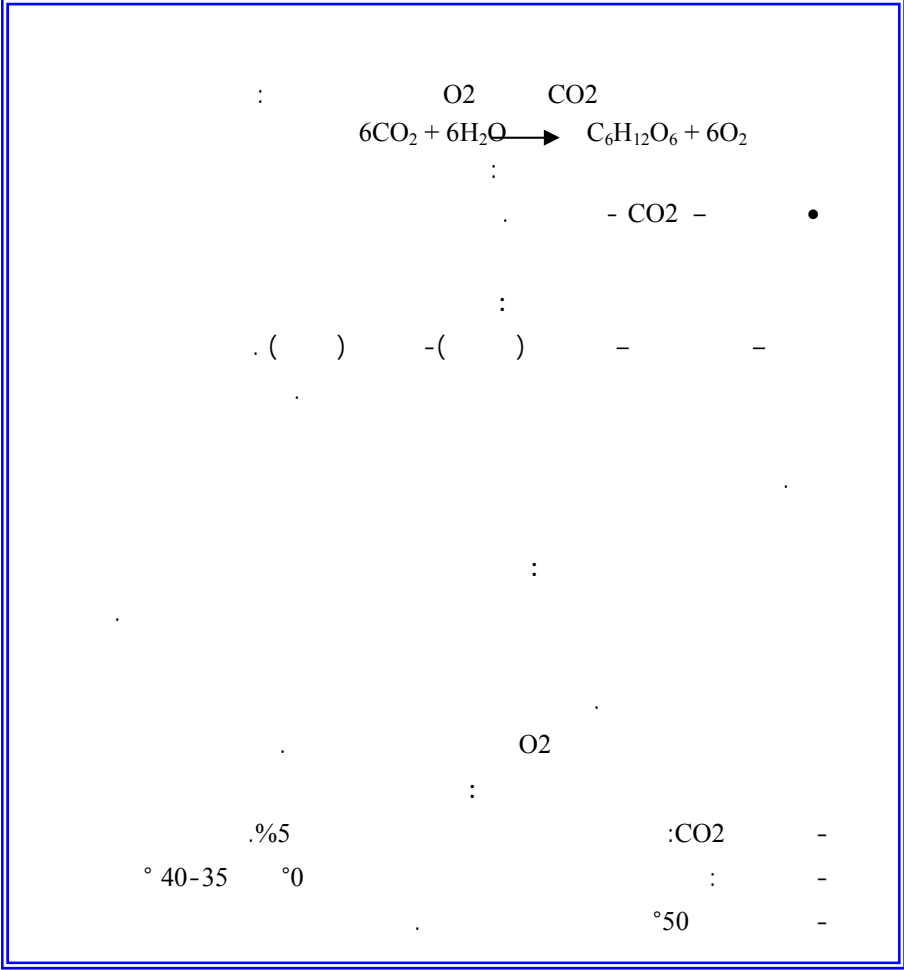

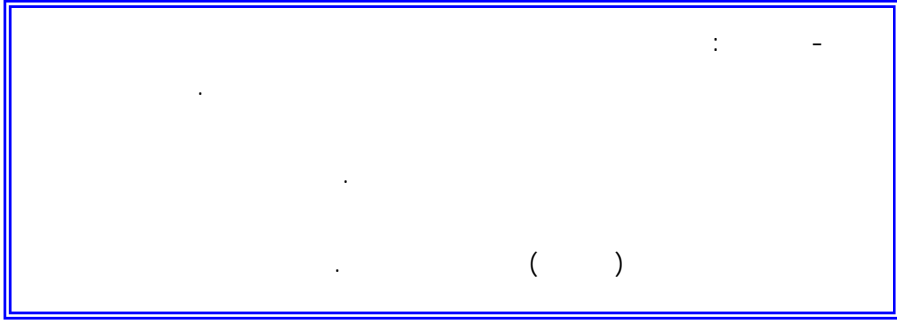

-12